



**Fitzpatrick  
Woolmer**

## Wallmounting Notice Board - Oak

Our **wall-mounting oak notice boards** combine natural elegance with practical functionality, ideal for heritage sites, parks, and community buildings. Made from FSC-certified oak, they offer a warm, traditional appearance while being built for long-lasting outdoor use.

The timber is treated for durability and weather resistance, with a design that suits both classic and mixed-style settings. Available in single or double door options, each board features secure, lockable doors and provides a sustainable, easy-to-maintain solution for public information display.

### Product features

- \* Hardwood FSC Oak construction
- \* Can be supplied with or without a header board
- \* Robust stainless steel locks
- \* Gas struts to support doors when open
- \* Tough 4mm clear polycarbonate window
- \* Vent holes to minimise condensation
- \* Preservative finish
- \* Standard sizes A2, A1 and A0
- \* 1 year manufacturer's warranty

**Fitzpatrick Woolmer Design & Publishing Limited**

Unit 7 Lakeside Park, Neptune Close, Rochester, Kent, ME2 4LT  
t: 01634 711 771 e: info@fwdp.co.uk w: fwdp.co.uk



By Appointment to His Majesty The King  
Manufacturer of Signs and Wayfinding  
Fitzpatrick Woolmer Design & Publishing Ltd, Kent

Specification applies to the standard product.  
 Our range of options usually allow us to accommodate any differences you may require.  
 Please contact us and we will be happy to support you in developing this specification to meet your requirements.

Option delete/ update as appropriate

**Manufacturer:** Fitzpatrick Woolmer,  
 Unit 7 Lakeside Park, Neptune Close,  
 Rochester, Kent, ME2 4LT.

**Tel:** 01634 711 771

**Email:** info@fwdp.co.uk

**Timber:** FSC Prime Grade to BS EN 975-1

**Species:** Oak and Eucalyptus (external grade plywood)

**Origin:** France and China

**Moisture content on delivery:** 10% - 20%

**Certification:** FSC chain of custody

**Finish:** Sadolin Classic wood preservative,  
 solvent based, matt

**Colour:** Light Oak

**Weight:** 46kg

**Guarantee:** One year manufacturer's warranty

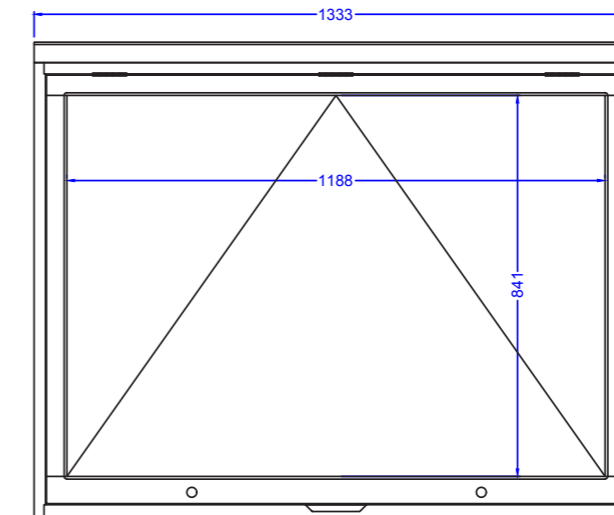
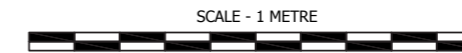
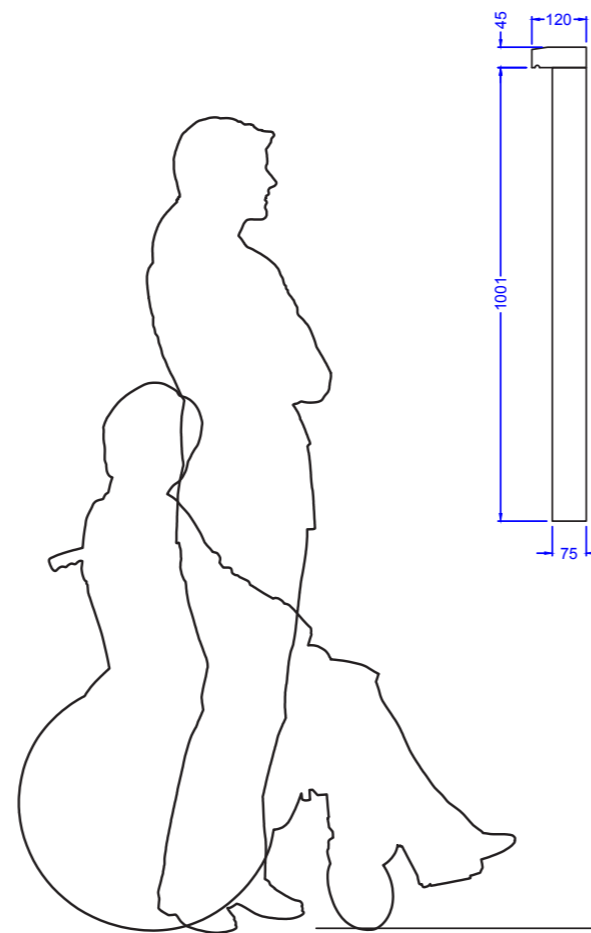

Note: All dimensions are indicative only. Footing details are subject to soil conditions and structural engineers recommendations.

Specification applies to the standard product. Our range of options usually allow us to accommodate any differences you may require. Please contact us and we will be happy to support you in developing this specification to meet your requirements.

Option delete/ update as appropriate

**Manufacturer:** Fitzpatrick Woolmer,  
Unit 7 Lakeside Park, Neptune Close,  
Rochester, Kent, ME2 4LT.

**Tel:** 01634 711 771

**Email:** info@fwdp.co.uk

**Timber:** FSC Prime Grade to BS EN 975-1

**Species:** Oak and Eucalyptus (external grade plywood)

**Origin:** France and China

**Moisture content on delivery:** 10% - 20%

**Certification:** FSC chain of custody

**Finish:** Sadolin Classic wood preservative,  
solvent based, matt

**Colour:** Light Oak

**Weight:** 54kg

**Guarantee:** One year manufacturer's warranty

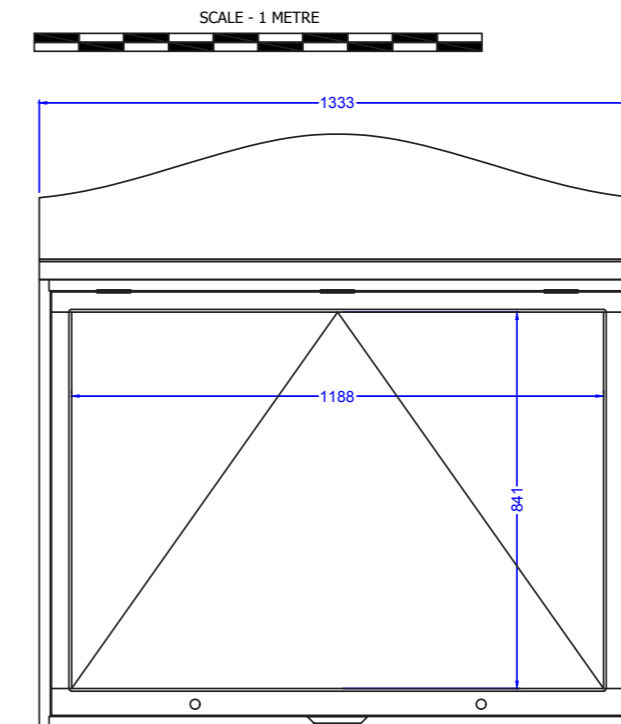
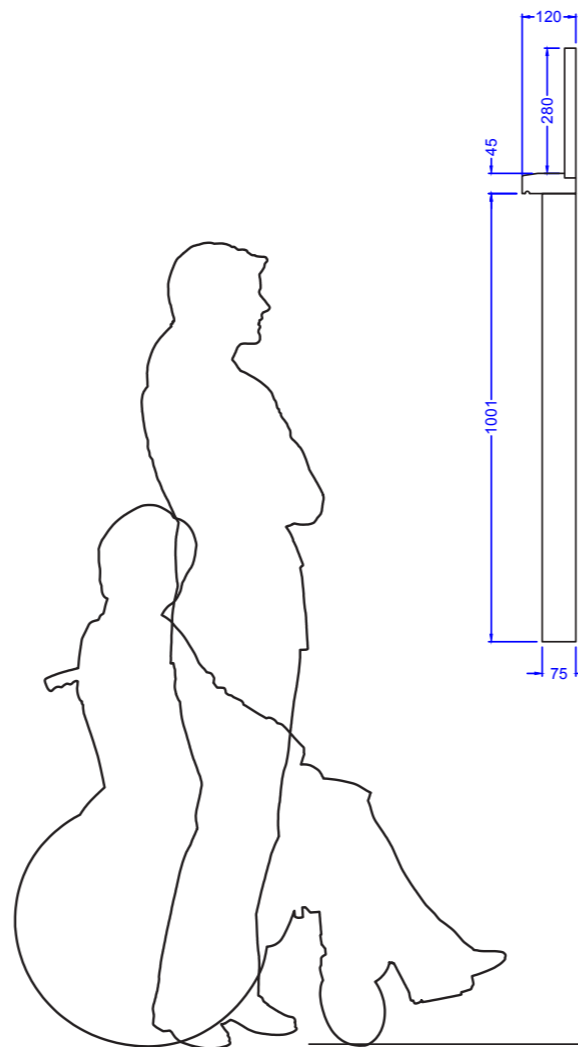

Note: All dimensions are indicative only. Footing details are subject to soil conditions and structural engineers recommendations.

Specification applies to the standard product.  
Our range of options usually allow us to accommodate any differences you may require. Please contact us and we will be happy to support you in developing this specification to meet your requirements.

Option delete/ update as appropriate

**Manufacturer:** Fitzpatrick Woolmer,  
Unit 7 Lakeside Park, Neptune Close,  
Rochester, Kent, ME2 4LT.

**Tel:** 01634 711 771

**Email:** info@fwdp.co.uk

**Timber:** FSC Prime Grade to BS EN 975-1

**Species:** Oak and Eucalyptus (external grade plywood)

**Origin:** France and China

**Moisture content on delivery:** 10% - 20%

**Certification:** FSC chain of custody

**Finish:** Sadolin Classic wood preservative,  
solvent based, matt

**Colour:** Light Oak

**Weight:** 55kg

**Guarantee:** One year manufacturer's warranty

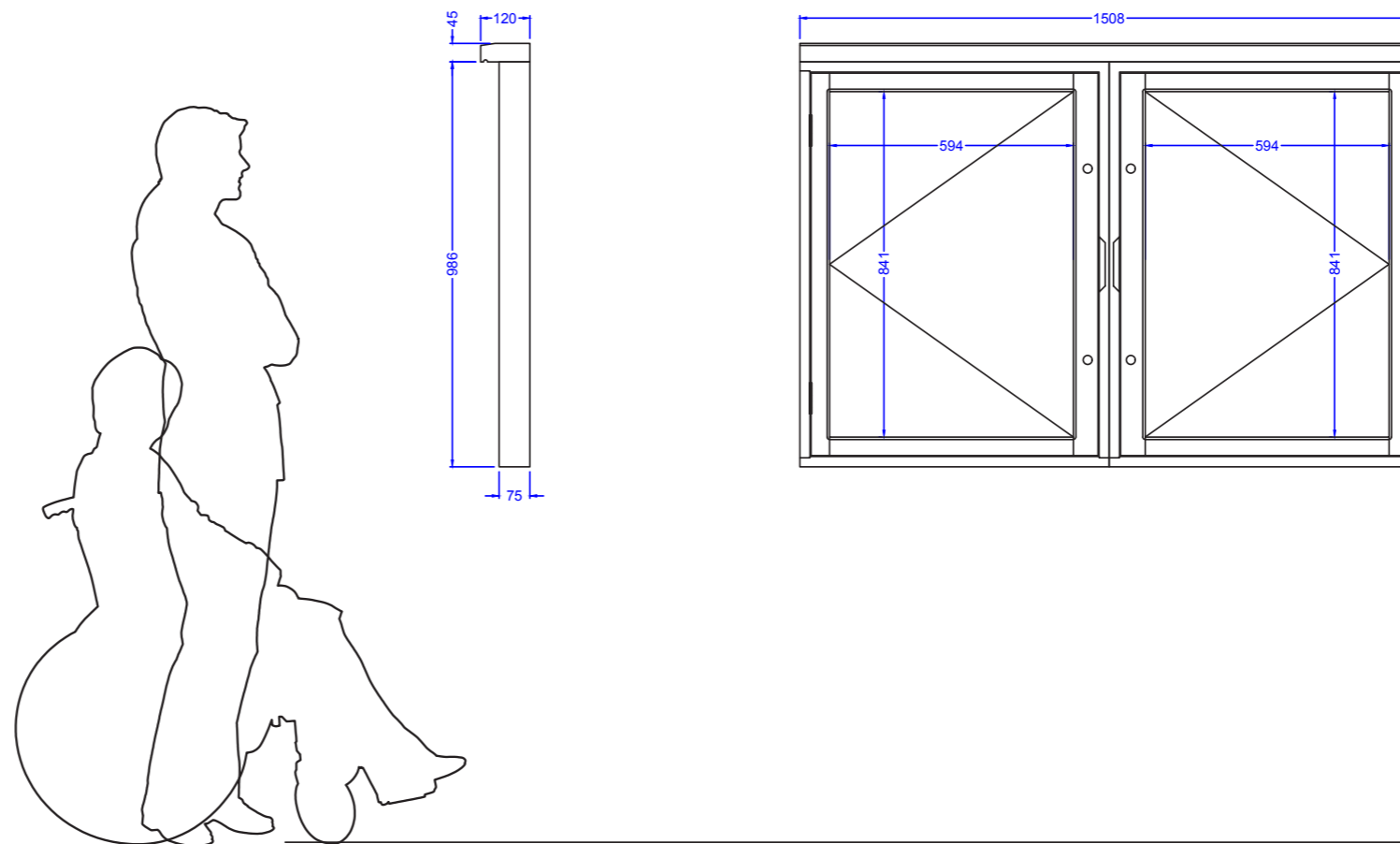

Note: All dimensions are indicative only. Footing details are subject to soil conditions and structural engineers recommendations.

Specification applies to the standard product.  
 Our range of options usually allow us to accommodate any differences you may require.  
 Please contact us and we will be happy to support you in developing this specification to meet your requirements.

Option delete/ update as appropriate

**Manufacturer:** Fitzpatrick Woolmer,  
 Unit 7 Lakeside Park, Neptune Close,  
 Rochester, Kent, ME2 4LT.

**Tel:** 01634 711 771

**Email:** info@fwdp.co.uk

**Timber:** FSC Prime Grade to BS EN 975-1

**Species:** Oak and Eucalyptus (external grade plywood)

**Origin:** France and China

**Moisture content on delivery:** 10% - 20%

**Certification:** FSC chain of custody

**Finish:** Sadolin Classic wood preservative,  
 solvent based, matt

**Colour:** Light Oak

**Weight:** 63kg

**Guarantee:** One year manufacturer's warranty

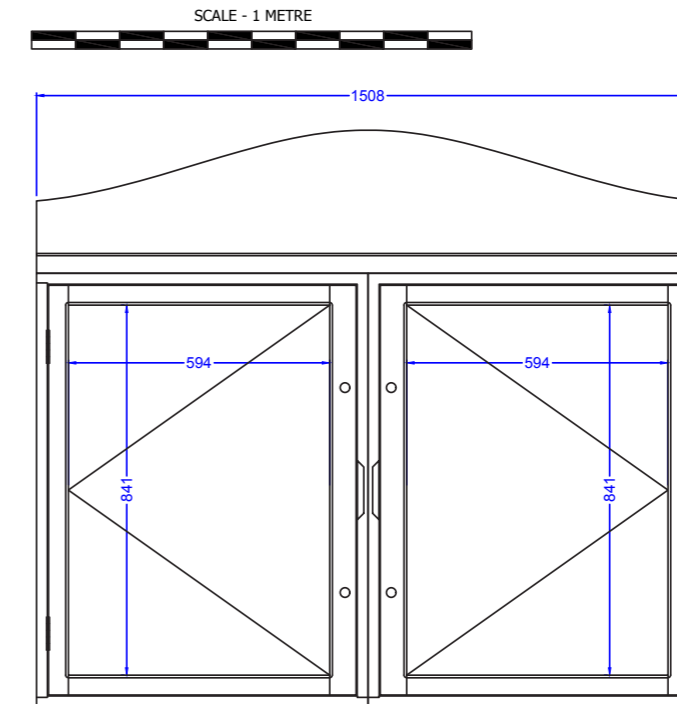
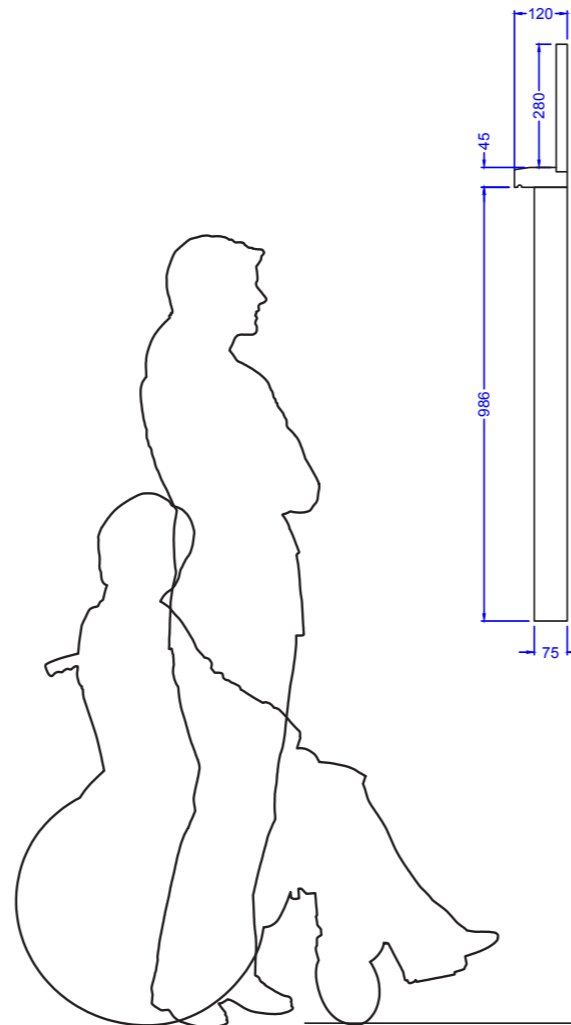

Note: All dimensions are indicative only. Footing details are subject to soil conditions and structural engineers recommendations.

Specification applies to the standard product.  
 Our range of options usually allow us to accommodate any differences you may require.  
 Please contact us and we will be happy to support you in developing this specification to meet your requirements.

Option delete/ update as appropriate

**Manufacturer:** Fitzpatrick Woolmer,  
 Unit 7 Lakeside Park, Neptune Close,  
 Rochester, Kent, ME2 4LT.

**Tel:** 01634 711 771

**Email:** info@fwdp.co.uk

**Timber:** FSC Prime Grade to BS EN 975-1

**Species:** Oak and Eucalyptus (external grade plywood)

**Origin:** France and China

**Moisture content on delivery:** 10% - 20%

**Certification:** FSC chain of custody

**Finish:** Sadolin Classic wood preservative,  
 solvent based, matt

**Colour:** Light Oak

**Weight:** 30kg

**Guarantee:** One year manufacturer's warranty

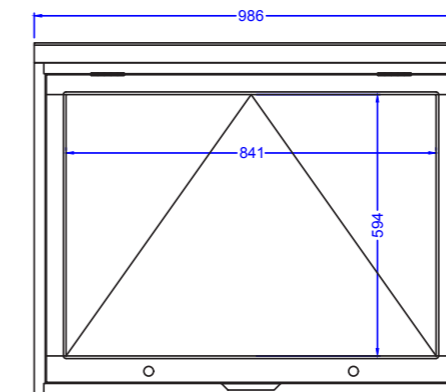
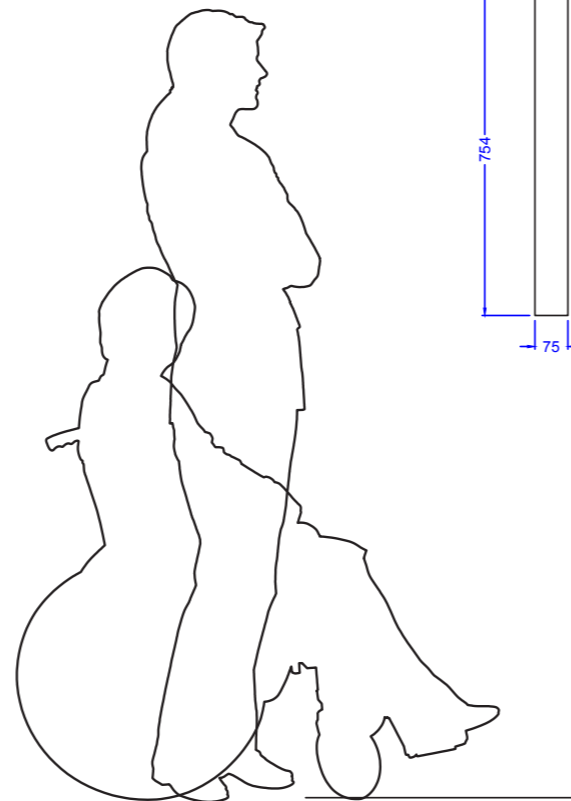

Note: All dimensions are indicative only. Footing details are subject to soil conditions and structural engineers recommendations.

Specification applies to the standard product. Our range of options usually allow us to accommodate any differences you may require. Please contact us and we will be happy to support you in developing this specification to meet your requirements.

Option delete/ update as appropriate

**Manufacturer:** Fitzpatrick Woolmer,  
Unit 7 Lakeside Park, Neptune Close,  
Rochester, Kent, ME2 4LT.

**Tel:** 01634 711 771

**Email:** info@fwdp.co.uk

**Timber:** FSC Prime Grade to BS EN 975-1

**Species:** Oak and Eucalyptus (external grade plywood)

**Origin:** France and China

**Moisture content on delivery:** 10% - 20%

**Certification:** FSC chain of custody

**Finish:** Sadolin Classic wood preservative,  
solvent based, matt

**Colour:** Light Oak

**Weight:** 35kg

**Guarantee:** One year manufacturer's warranty

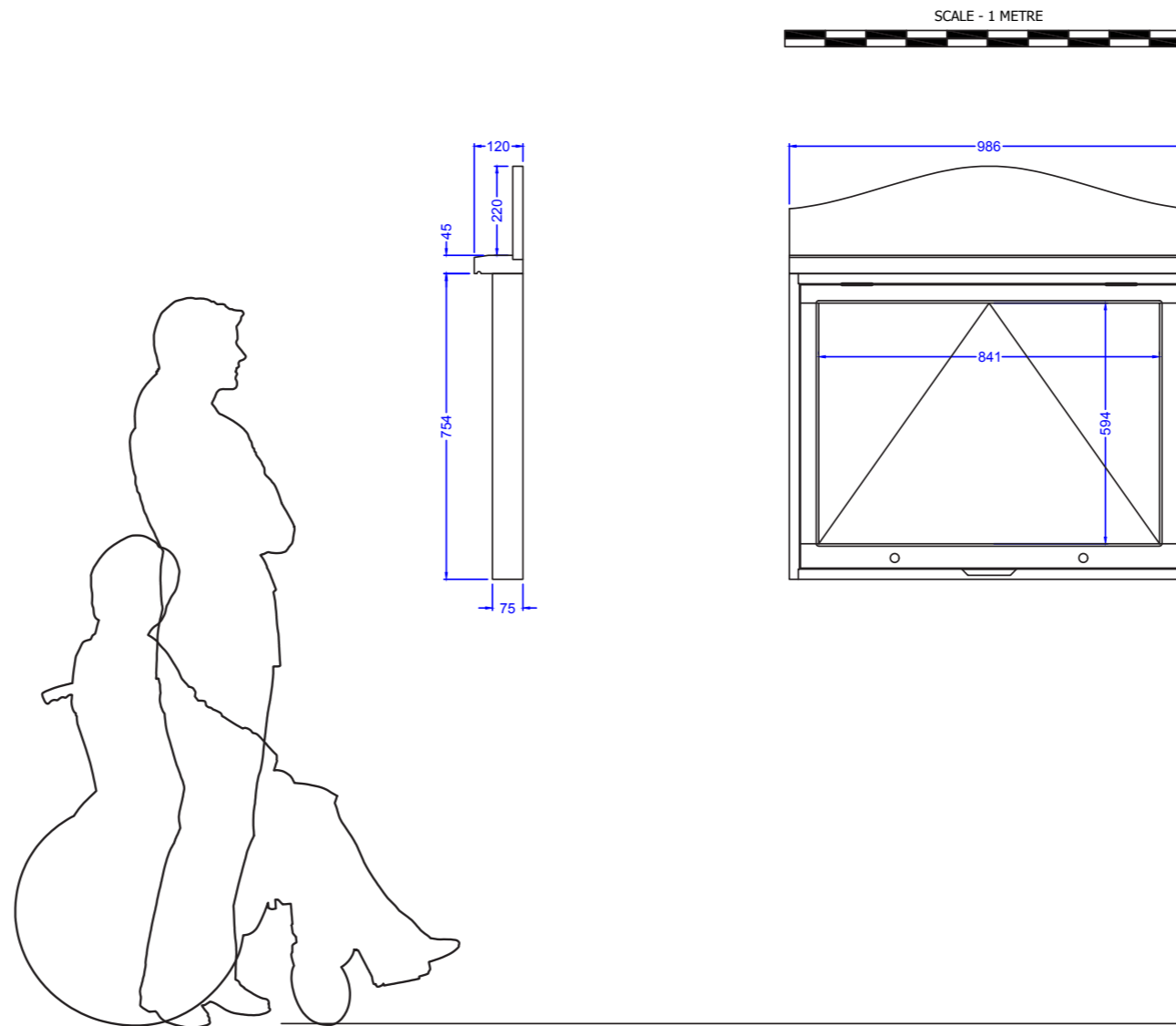

Note: All dimensions are indicative only. Footing details are subject to soil conditions and structural engineers recommendations.

Specification applies to the standard product.  
 Our range of options usually allow us to accommodate any differences you may require.  
 Please contact us and we will be happy to support you in developing this specification to meet your requirements.

Option delete/ update as appropriate

**Manufacturer:** Fitzpatrick Woolmer,  
 Unit 7 Lakeside Park, Neptune Close,  
 Rochester, Kent, ME2 4LT.

**Tel:** 01634 711 771

**Email:** info@fwdp.co.uk

**Timber:** FSC Prime Grade to BS EN 975-1

**Species:** Oak and Eucalyptus (external grade plywood)

**Origin:** France and China

**Moisture content on delivery:** 10% - 20%

**Certification:** FSC chain of custody

**Finish:** Sadolin Classic wood preservative,  
 solvent based, matt

**Colour:** Light Oak

**Weight:** 35kg

**Guarantee:** One year manufacturer's warranty

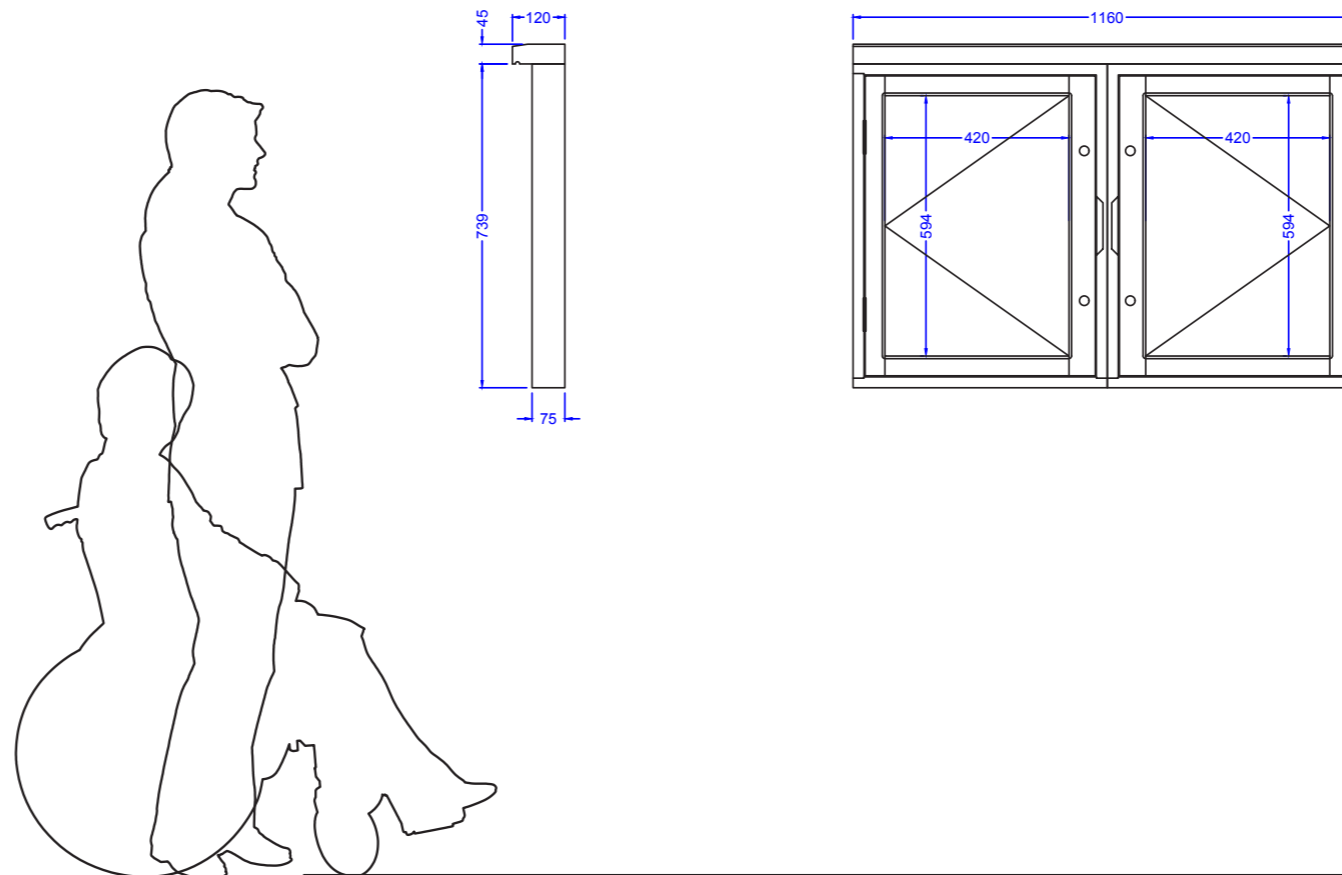

Note: All dimensions are indicative only. Footing details are subject to soil conditions and structural engineers recommendations.

Specification applies to the standard product.  
Our range of options usually allow us to accommodate any differences you may require. Please contact us and we will be happy to support you in developing this specification to meet your requirements.

Option delete/ update as appropriate

**Manufacturer:** Fitzpatrick Woolmer,  
Unit 7 Lakeside Park, Neptune Close,  
Rochester, Kent, ME2 4LT.

**Tel:** 01634 711 771

**Email:** info@fwdp.co.uk

**Timber:** FSC Prime Grade to BS EN 975-1

**Species:** Oak and Eucalyptus (external grade plywood)

**Origin:** France and China

**Moisture content on delivery:** 10% - 20%

**Certification:** FSC chain of custody

**Finish:** Sadolin Classic wood preservative,  
solvent based, matt

**Colour:** Light Oak

**Weight:** 40kg

**Guarantee:** One year manufacturer's warranty

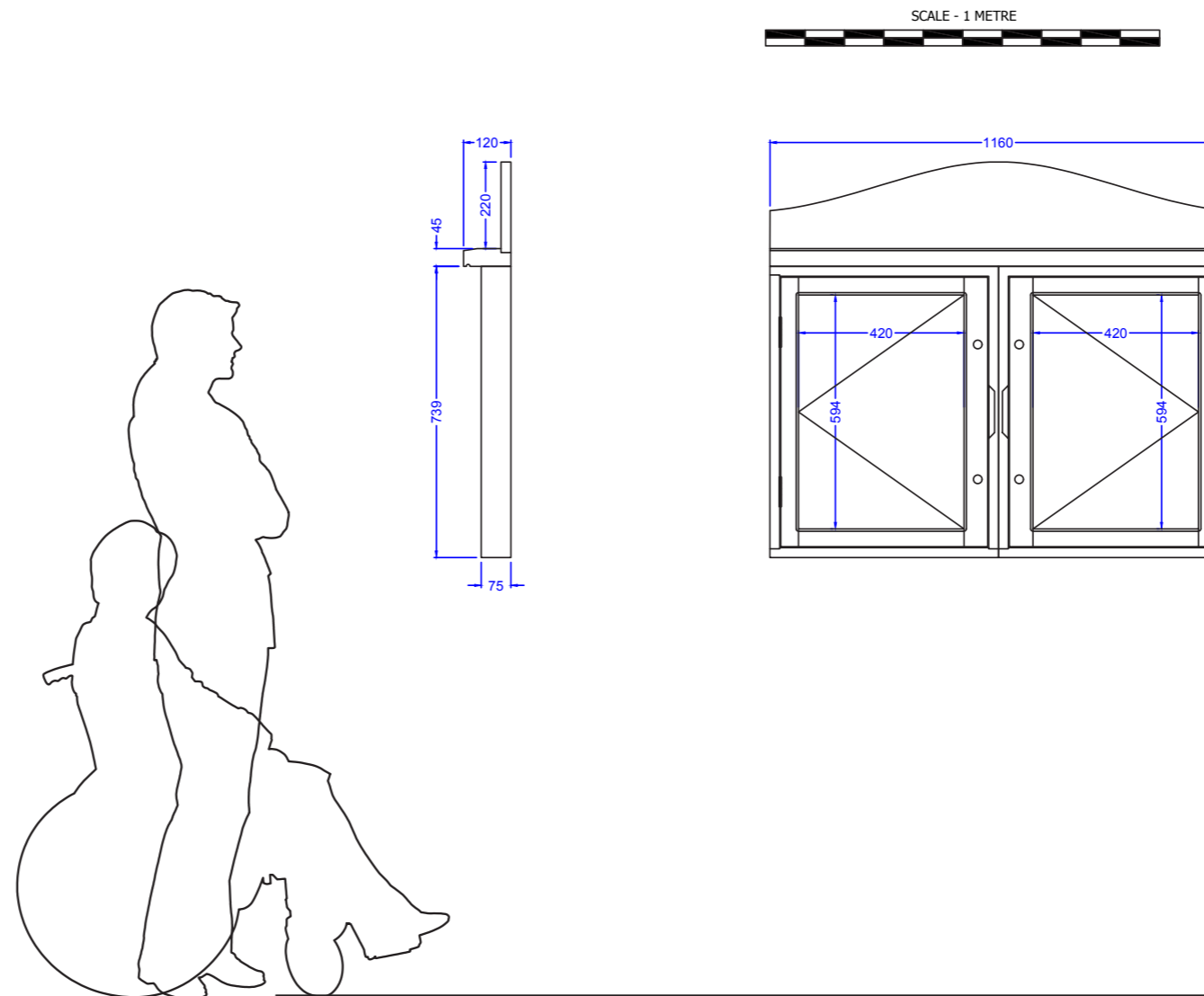

Note: All dimensions are indicative only. Footing details are subject to soil conditions and structural engineers recommendations.

Specification applies to the standard product.  
 Our range of options usually allow us to accommodate any differences you may require.  
 Please contact us and we will be happy to support you in developing this specification to meet your requirements.

Option delete/ update as appropriate

**Manufacturer:** Fitzpatrick Woolmer,  
 Unit 7 Lakeside Park, Neptune Close,  
 Rochester, Kent, ME2 4LT.

**Tel:** 01634 711 771

**Email:** info@fwdp.co.uk

**Timber:** FSC Prime Grade to BS EN 975-1

**Species:** Oak and Eucalyptus (external grade plywood)

**Origin:** France and China

**Moisture content on delivery:** 10% - 20%

**Certification:** FSC chain of custody

**Finish:** Sadolin Classic wood preservative,  
 solvent based, matt

**Colour:** Light Oak

**Weight:** 19kg

**Guarantee:** One year manufacturer's warranty

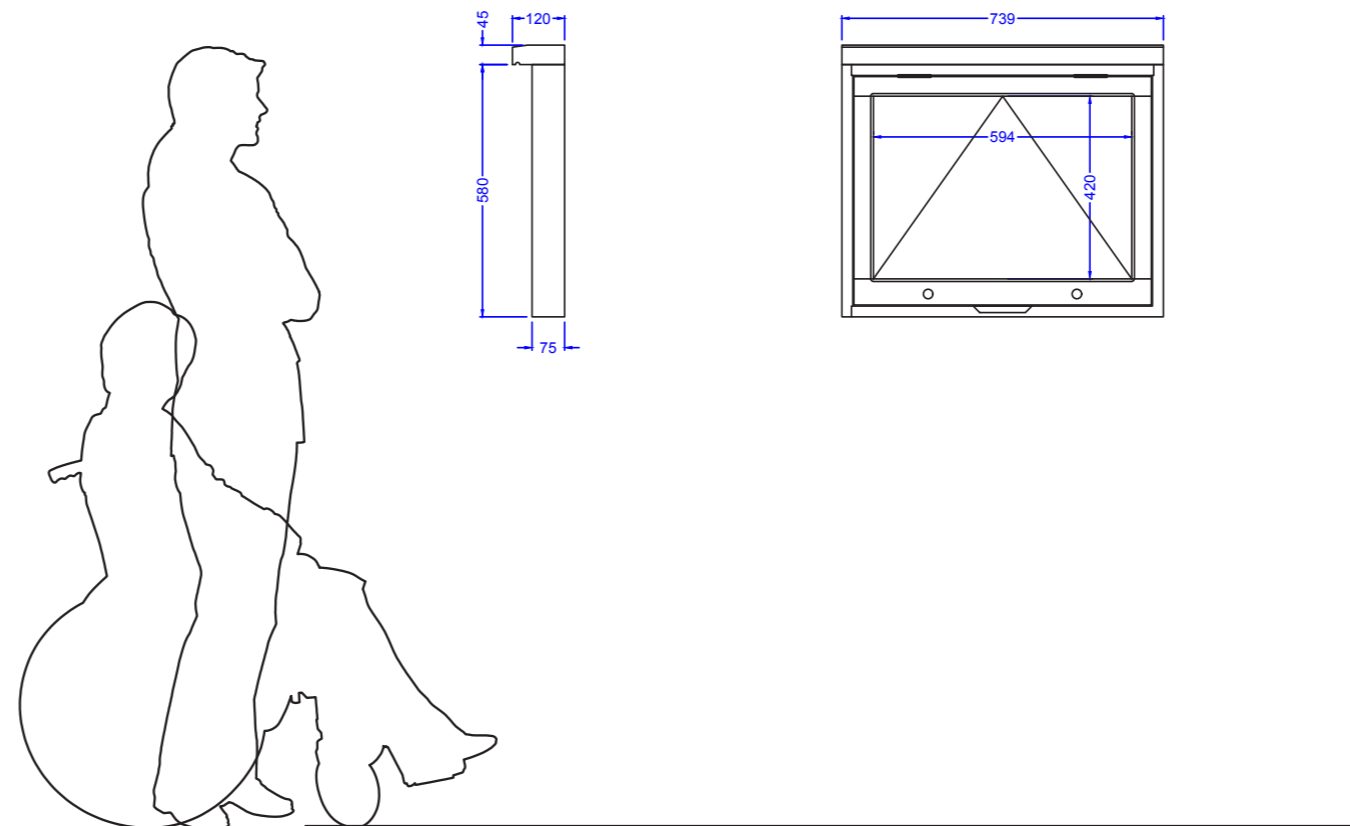

Note: All dimensions are indicative only. Footing details are subject to soil conditions and structural engineers recommendations.

Specification applies to the standard product.  
 Our range of options usually allow us to accommodate any differences you may require.  
 Please contact us and we will be happy to support you in developing this specification to meet your requirements.

Option delete/ update as appropriate

**Manufacturer:** Fitzpatrick Woolmer,  
 Unit 7 Lakeside Park, Neptune Close,  
 Rochester, Kent, ME2 4LT.

**Tel:** 01634 711 771

**Email:** info@fwdp.co.uk

**Timber:** FSC Prime Grade to BS EN 975-1

**Species:** Oak and Eucalyptus (external grade plywood)

**Origin:** France and China

**Moisture content on delivery:** 10% - 20%

**Certification:** FSC chain of custody

**Finish:** Sadolin Classic wood preservative,  
 solvent based, matt

**Colour:** Light Oak

**Weight:** 22kg

**Guarantee:** One year manufacturer's warranty

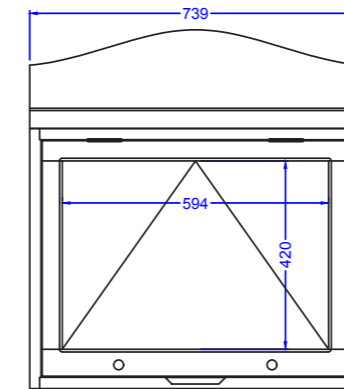
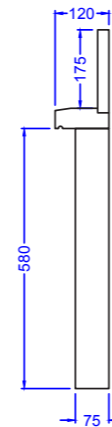
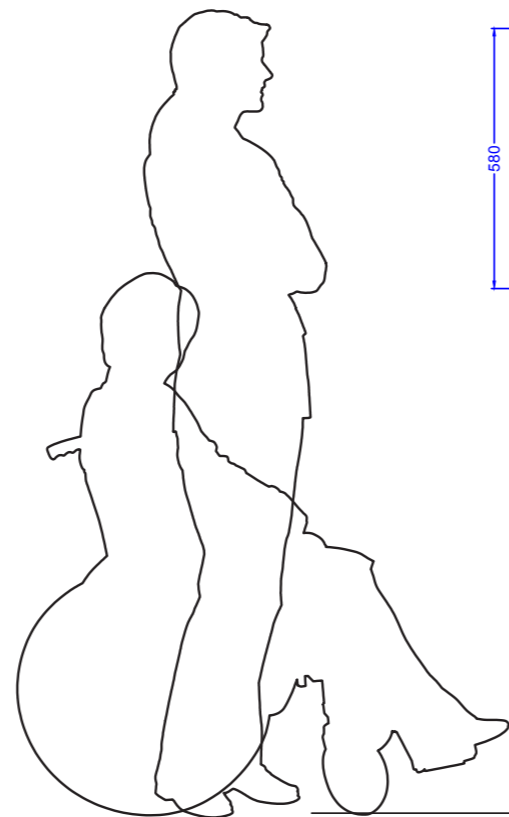

Note: All dimensions are indicative only. Footing details are subject to soil conditions and structural engineers recommendations.